EVOKO

Evoko Liso – Product Overview

Evoko Room Manager has taken the hassle out of meeting room bookings since 2009...

- No more double bookings
- No more interrupted meetings
- Easily find available rooms for ad-hoc meetings
- Report broken equipment right from the screen
- A beautiful design
- Valuable data to optimize resource usage and improve meeting culture
- Best in class usability
- Minimal impact on existing IT infrastructure



... and we have been globally recognized for our product design and innovation...



reddot



product design award

2011



LD TECH DECISIONS
13 Best Corporate Products of 2015









WHO WE ARE

...helping organizations from all industries and sizes to have magnificent meetings



Making meetings even smoother with Evoko Liso!

Just like the Evoko Room Manager, Evoko Liso:

-  Takes the hassle out of meeting room booking
-  Clearly shows the status outside the meeting rooms
-  Puts an end to double bookings, confusion and interrupted meetings
-  Is easy to use
-  Has an award-winning, beautiful and stylish design
-  Frees up rooms that are booked but not used
-  Provides you with statistics to optimize resources and improve meeting culture



Bright and helpful

- **See at a glance which rooms that are available**
 - Thanks to the green, amber and red light aura
- **Easier than ever to book**
 - Use your favorite digital calendar on any computer, tablet or smartphone
 - Book directly on the Evoko Liso with the touch of your finger
 - Make instant or future bookings for any room included in the Liso installation
 - Search for and book meetings based on location, availability, size and equipment
- **A new level of intuitive user interface**
 - All information is elegantly presented on the screen and it changes information automatically on the display when you walk up to it – making sure the most relevant information always is displayed



Analytical and efficient

- **Get full insights on meeting patterns**
 - Get an extensive view of your organization's meeting patterns to optimize resources and improve meeting culture
- **Decision-making support**
 - Truly cuts costs by optimizing resources and improving the meeting culture
 - Comprehensive statistics
- **Extensive multi-site management options**
 - Manage large installations that cover *multiple locations*
 - Automatic *import of room lists and users* directly from the calendar service
 - Hierarchy settings for *rooms, groups* and *settings*
 - Permission control with different user levels; *Global administrator, Local administrator, User*
 - Real-time *monitoring* function
 - *Remote management and upgrade* functionality (scheduled updates, selective room/group upgrades etc.)

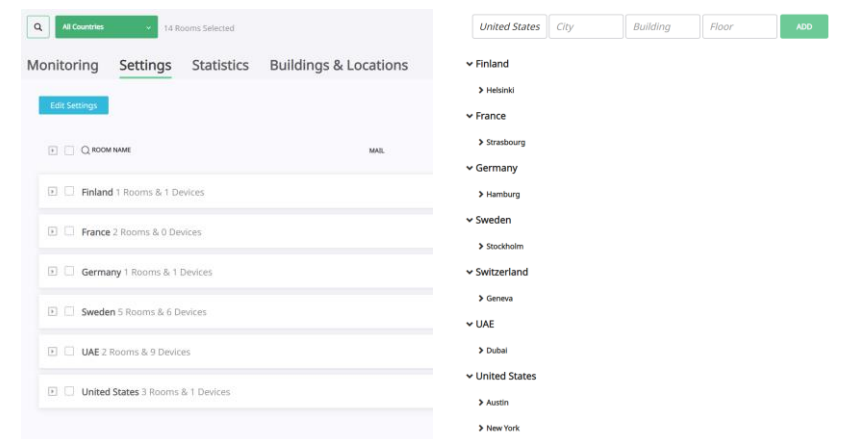
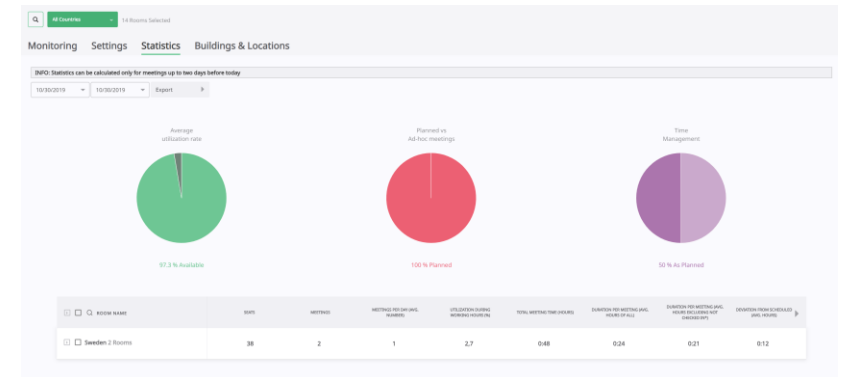

Open and interactive

- **Open API for integration with 3rd party systems**
 - E.g. automatically have the AC turn on 10 min before a meeting is scheduled to start
- **RFID/PIN verification**
 - For identification at on-screen bookings and restrict access for certain rooms, users or functions
- **Check-in function**
 - Helps you free up meeting space by automatically cancelling bookings where no-one shows up
- **Report non-functioning equipment**
 - Nonfunctioning equipment in the room can be reported directly on the Evoko Liso screen to automatically notify the Facility Manager

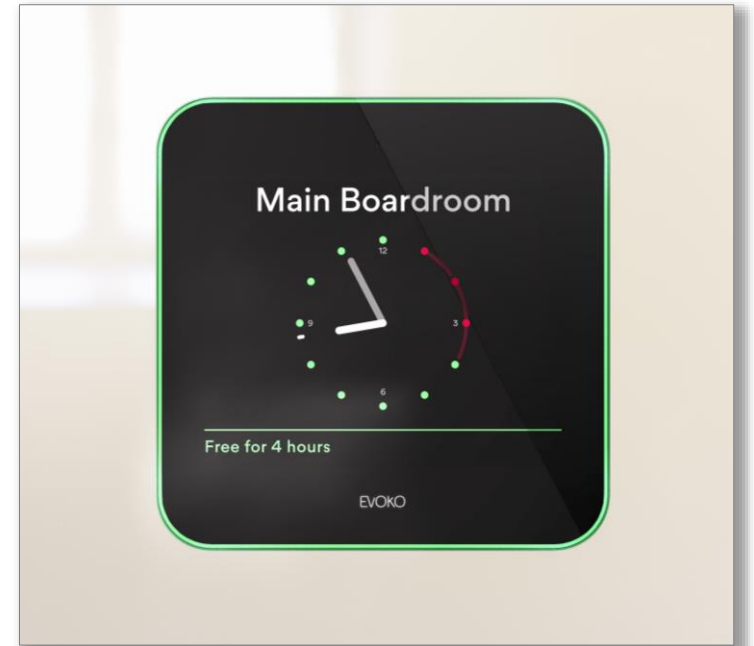

Simple and beautiful

- **Easy to use**
 - Ensures quick and high adoptability
 - No new software and no additional plug-ins to learn
- **Self-explanatory**
 - Anyone can master it without prior training
 - All features can be reached with only a few simple touches
- **Designed by No Picnic**
 - The award winning Swedish designers
- **Easy to install on both regular and glass walls**
 - Mounting Kits are included on product purchase
- **Cable routing in 5 directions**
 - For easy installation on any wall

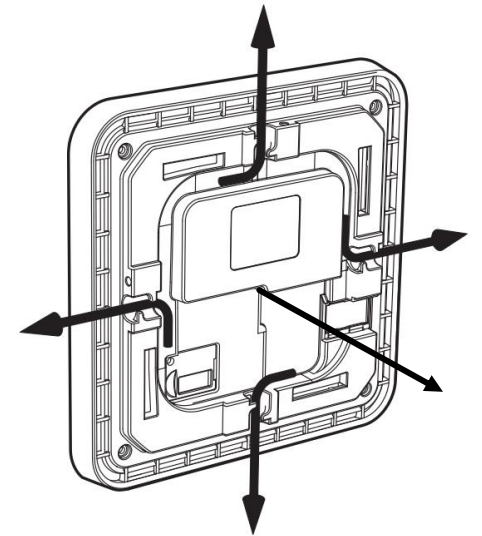
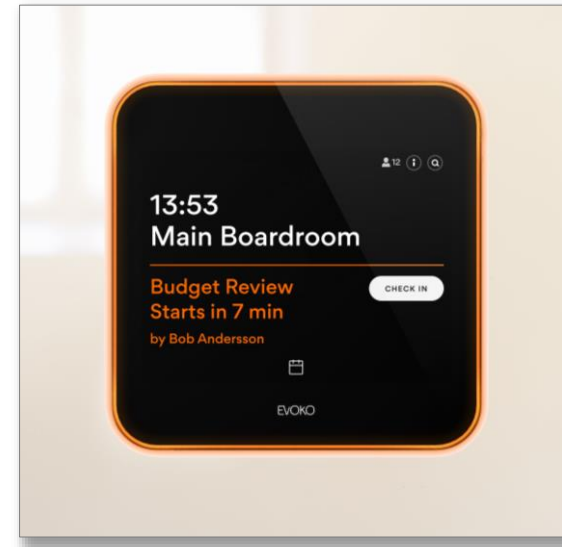

The Evoko Liso eco-system is add-on solutions to further improve efficiency, available free-of-charge when purchasing Evoko Liso

More details available on our Knowledge Base, www.evoko.se/support

SMARTPHONE APP "GET A ROOM"



The Evoko smartphone app "Get a room" makes room booking on-the-go even easier.

- Available for iOS and Android

EVOKO OVERVIEW SCREEN

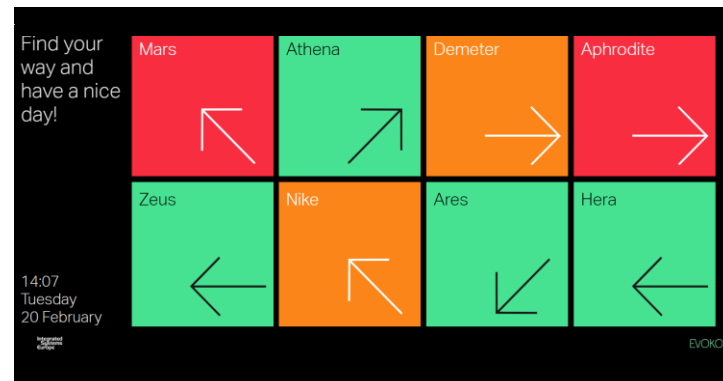

With Evoko Overview screen you can use a large screen to display the current status of selected rooms and get up-to-date status.

- Ideal in the reception or lobby

EVOKO BOOKING

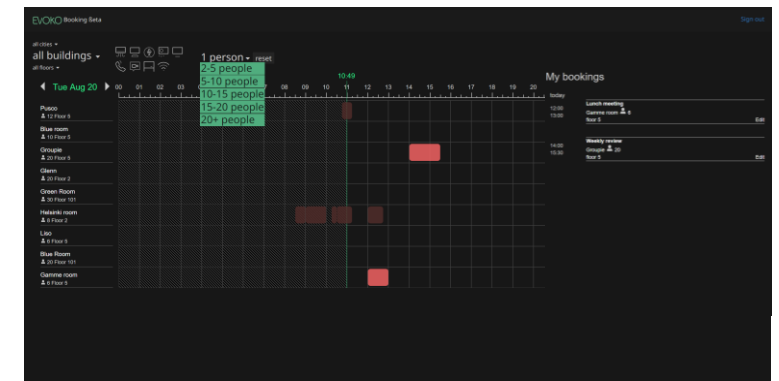

Use Evoko Liso without an external booking system – perfect for co-working spaces. Users on different domains can now access and benefit from the Evoko Liso solution.

- A stand-alone booking system for Evoko Liso

Simplicity is resonated in our pricing model

One of our most important brand values is Simplicity, which is why it has been important for us to develop a simplistic pricing model

- Evoko has a unique business model that stands out from the competition. Customer only pay a fixed amount per Evoko Liso unit **once** - after the initial purchase there are **no future fees or costs**
 - No license fees
 - No recurring costs
 - Better control over TCO
- All future updates, including **GUI updates, Firmware updates, Software releases** etc. are **free of charge** and will continue to be offered as long as the solution is in use by the customer

Included in product purchase

The following is included with purchase of Evoko Liso:

- Evoko Liso room manager device
- Mounting kit (standard wall)
- Mounting kit (glass wall)
- Evoko Home application
- Future software upgrades: Evoko Liso and Evoko Home
- 2-year warranty
- Product support via e-mail/web tickets

Note: AC power supply will only be shipped if requested (Evoko Liso is typically installed with PoE)

Overview System Architecture

The Evoko room booking solution consists of:

- **Evoko Liso** devices, that are installed outside the meeting rooms
- **Evoko Home** application, which is used to manage the Liso devices and connects to the booking system
- **Booking system** – Evoko Liso works with all major booking systems, including Office365, Exchange and Google G Suite

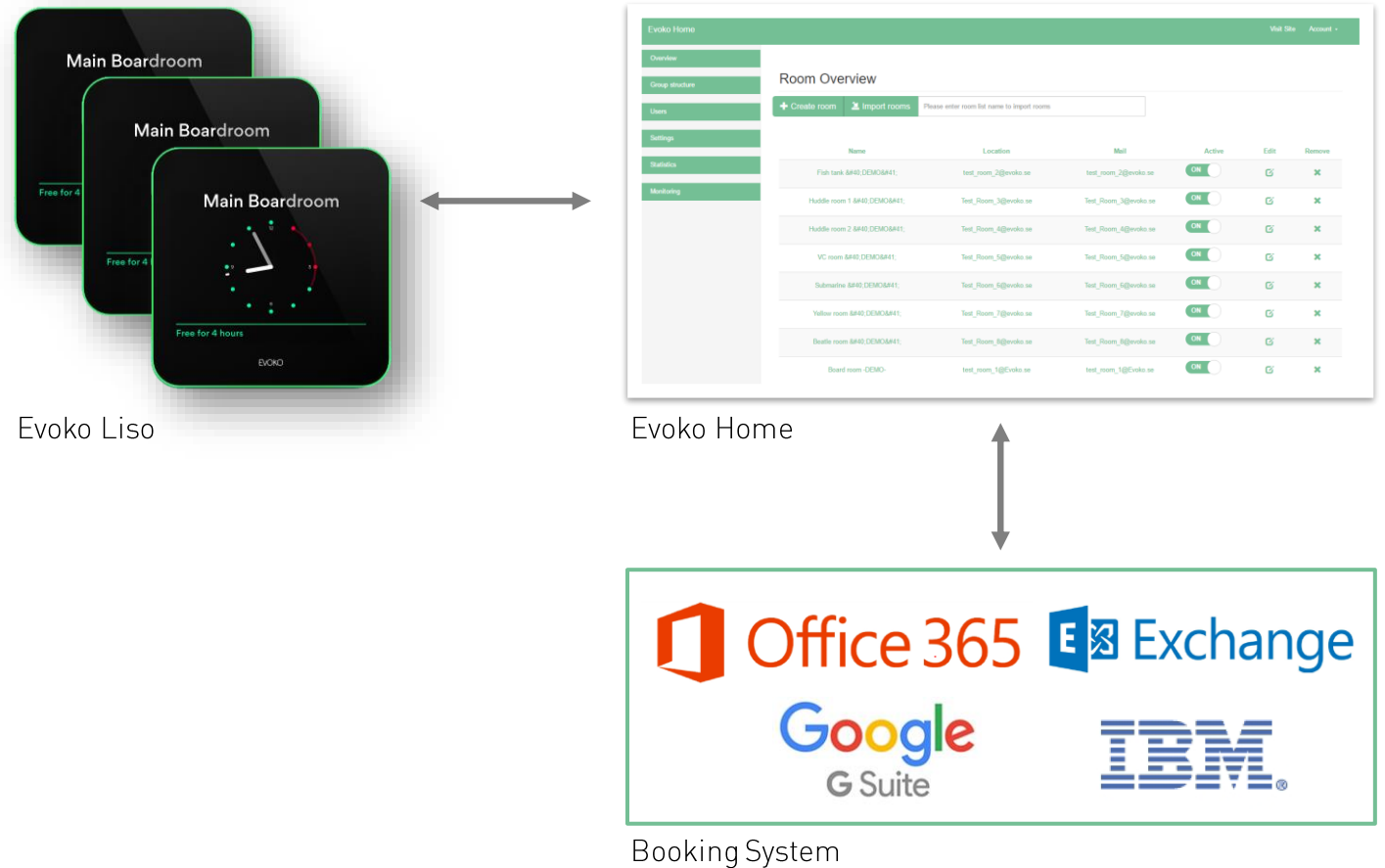

Evoko Knowledge Base helps you get Evoko Liso up and running

Step-by-step instructions and useful guides available from www.evoko.se/support

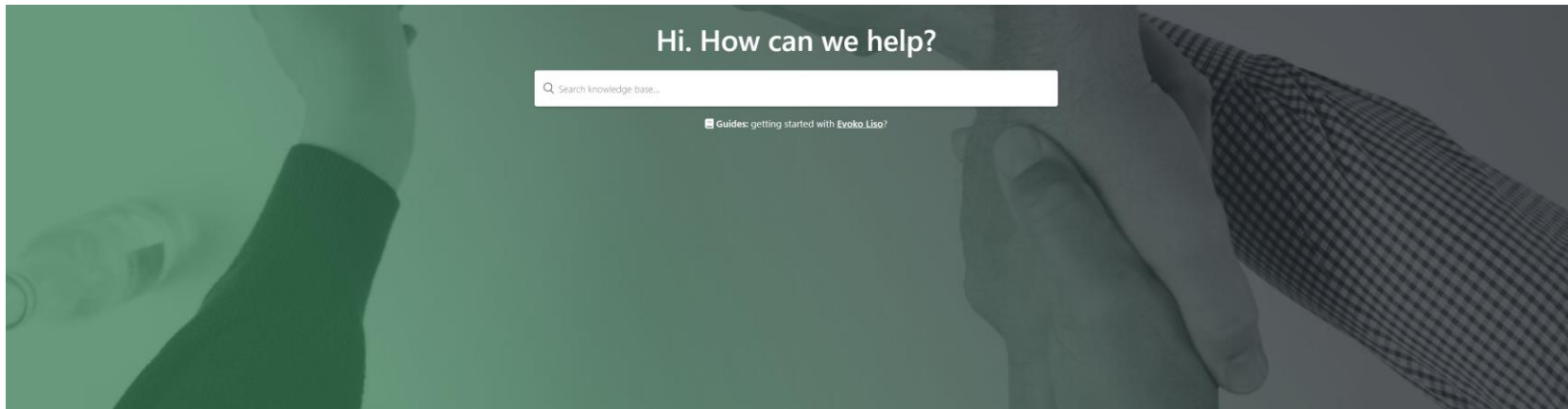

Browse knowledge base



EVOKO

MEETINGS MADE MAGNIFICENT