

PAPERFLIGHT SERIES

VZ-8plus<sup>2</sup>  
VZ-8light<sup>2</sup>

**WOLFVISION**<sup>®</sup>  
*Visualizer* ENGLISH

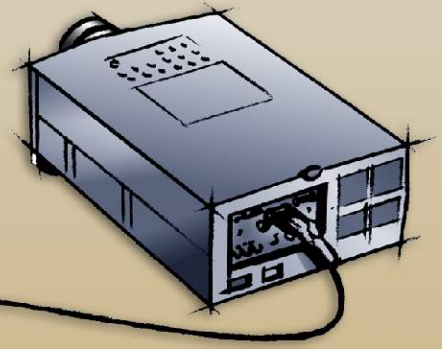
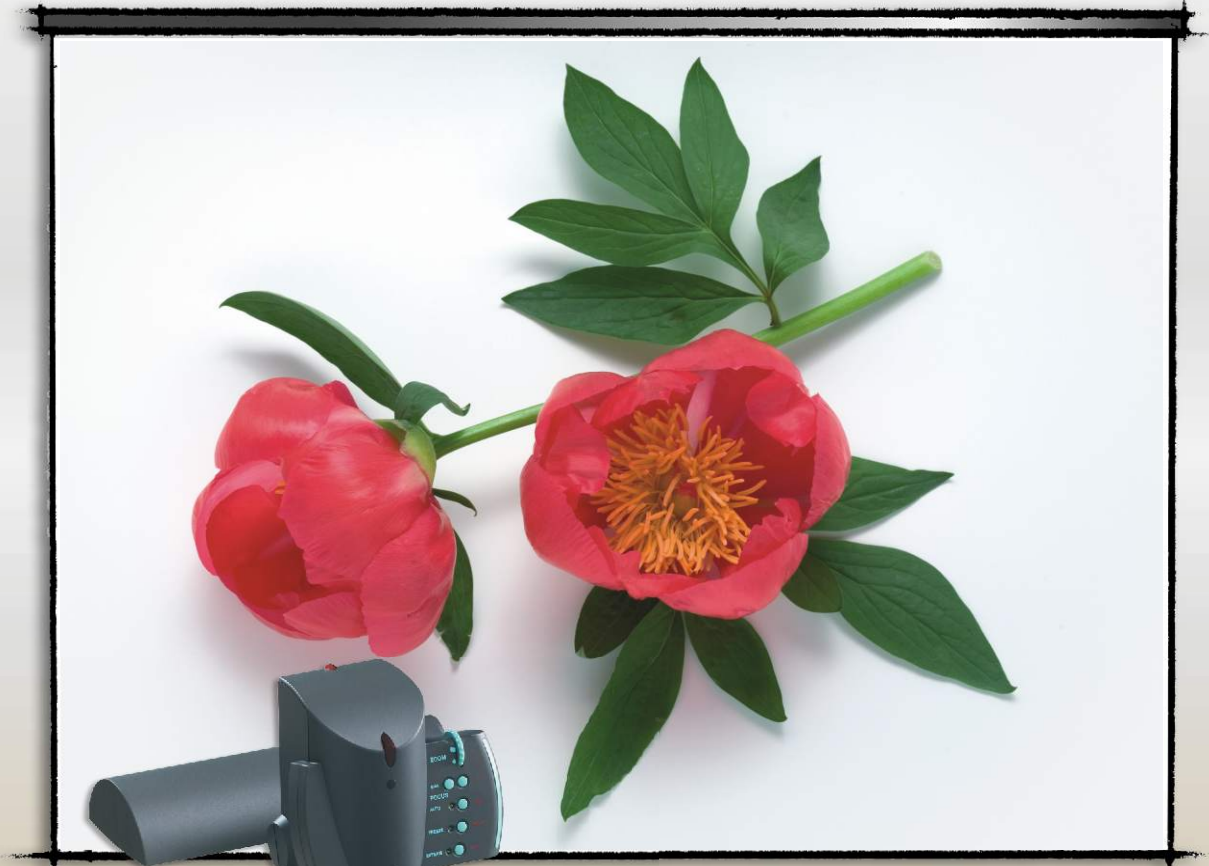

**VZ-8 Series**  
**Second Edition**

## Unique folding system / Set up in seconds



WolfVision's portable Visualizers can be set up in seconds. A gentle tug lifts the arm and light into the working position. The user then needs only to turn the camera head to the desired viewing angle.

Just as easily, it folds back into its compact size with just one pull on the center ring, to be neatly stored during or after a presentation.

The units fit perfectly in a drawer. The height when folded is only 122mm / 4.8".

## Camera Head / Zoom Wheel / Easy Handling Concept



For smooth presentations, it is necessary that the Visualizer is **very easy to use**. Everyone should be able to operate the Visualizer immediately, **without any instructions**.

Normally users need only to use the **zoom wheel** on top of the camera head. Everything else (focus, iris etc.) is adjusted **automatically**.

The zoom wheel offers the possibility to zoom with **two speeds**.

The other 5 keys on the camera head include important functions like autofocus on/off, manual focus, freeze and Ext/Int. More functions are available on the remote control of the VZ-8plus<sup>2</sup>.

Most functions on the Visualizer can also be controlled without remote control. Functions like menu settings and Preset 1 are available as double functions if the keys on the camera head are pressed for 1 second.



## 100% Reflection free Working Surface / Slide-through

Due to the clever design of the new housing, the whole working surface is **completely reflection free**.

In the upper part the working surface, where the light is normally reflected into the camera, the surface is slightly curved, so that reflections are not possible on any part of the working surface.

The new, flat design also allows moving objects around on the whole working surface without any obstacles. Even oversized documents (like the calendar seen in the picture on the left) can be moved to the back without being blocked by the device.

## No Light Adjustments Necessary



VZ-8plus<sup>2</sup> and VZ-8light<sup>2</sup> come with a newly designed camera arm and light. The light is optimized for the working surface and there is never a need for any light adjustments.

The camera arm can be moved up and down at an angle of 90 degrees. The light is fixed onto the camera arm and moves together with the camera. Therefore, it is also possible to illuminate the area in front or behind the working surface.

The light of the Visualizers is focused on the working surface. Neither the audience nor the speaker will be blinded in a darkened room and there is no disturbing stray light from the Visualizer on the projection screen.

For recording objects at greater distances to the device, the close-up lens of the Visualizers can be hinged away from the camera. It won't get lost because it remains attached to the unit.



## Recordings Behind the Unit

When objects are too big to be placed on the working surface or need to be shown from the side (like glasses of liquids etc.), the camera head and the light of the portable Visualizers can be turned to accommodate them.

In this way a Visualizer can be used like a video camera, to record people, large objects, pictures or charts in a room.

## Recordings in Front of the Unit - with "Image Flip"

The Visualizer can not only record objects from behind the unit. The camera head can also be turned to record in front of the unit.

This is perfect for recording a speaker or charts on a wall behind the speaker. When the camera is turned to record in front of the unit, the image is automatically turned around 180 degrees ("image flip"), because normally such recordings would be upside down.





# State of the Art Picture Quality: Progressive Scan with 30 Pictures per Second

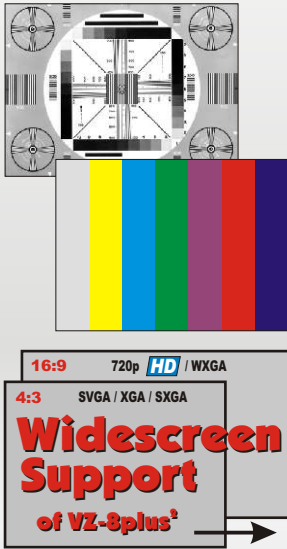

The key elements of the exceptional picture quality are:

- **WolfVision's Progressive Scan lens** (The image is extremely sharp, even in the corners of the picture)
- **WolfVision's Progressive Scan camera** (Resolution and color reproduction are outstanding.)
- **WolfVision's Intelligent Electronics**

VZ-8plus<sup>2</sup> and VZ-8light<sup>2</sup> output a native **XGA** signal on RGB (15-Pin D-Sub) outputs.

The VZ-8plus<sup>2</sup> also offers a digital **DVI** port and can be switched to output SVGA, SXGA, SXGA+ or SXGA- mode (at 75 or 60Hz). The original Progressive Scan signal is also output converted into PAL or NTSC video (switchable).

The native signal output of both units is **XGA** with an aspect ratio of **4:3**.

VZ-8plus<sup>2</sup> and VZ-8light<sup>2</sup> can also output the image converted into the following **16:9 widescreen** formats: **720p HD (High Definition)** at 50 or 60 Hz and **WXGA**. All widescreen projectors, monitors or plasma displays on the market can display at least one of these standards.



connectors of VZ-8plus<sup>2</sup>

**Auto Resolution:** The Visualizer recognizes units connected to the DVI and RGB output and automatically selects the perfect output mode.

**REAL TIME**  
**30**  
Frames per Second

**"Motion"** used to be the weakness of Progressive Scan cameras. Until recently they could only pick up 15 or less pictures per second. A low number of pictures per second often resulted in a disturbing strobe effect on the screen, whenever something was moved in the picture or when adjusting the zoom or iris.

WolfVision's Progressive Scan Visualizers could always pick up at least 20 pictures per second, which is very important to show motion in good quality.

WolfVision has improved the technical standards for Progressive Scan cameras even more. All current WolfVision Visualizer models can now pick up **30 pictures (frames) per second**. There is almost no difference in the smoothness of motion, when compared to PAL/NTSC video cameras. But the resolution is much higher!

## 24x Zoom (12x Optical and 2x Digital)

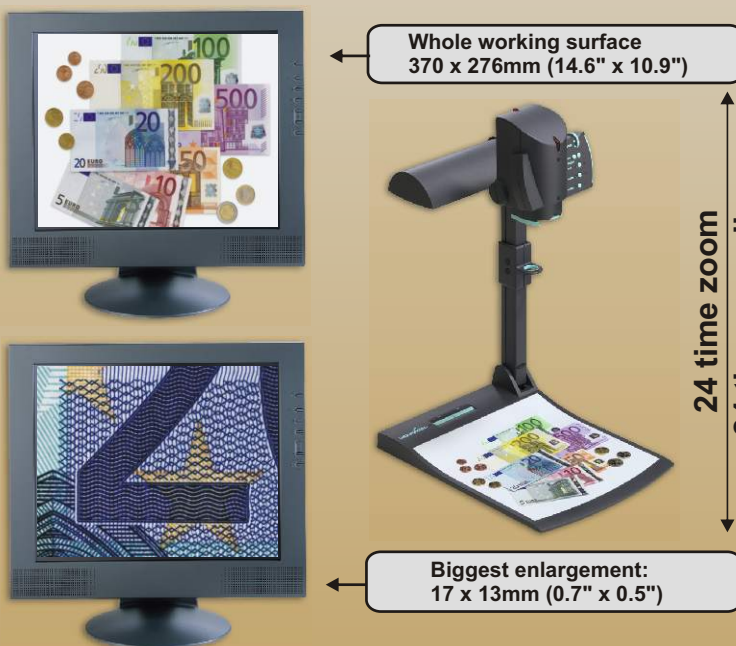

A large optical zoom range is one of the most important features of a Visualizer. It is absolutely necessary that objects in every size can be picked up in full resolution.

WolfVision's **optical 12 times zoom** offers the possibility to pick up objects as large as an open book (370 x 276mm / 14.6" x 10.9") and as small as a stamp (33 x 25mm / 1.3" x 1") in full size to fill the screen.

For enlarging even smaller objects down to 17 x 13mm (0.7" x 0.5") the Visualizers also offer a **2x digital zoom**. This enables users to enlarge objects such as a very small coin.

Due to the large range optical zoom, it is not necessary to use much of the digital zoom, so in most cases, you can work with full resolution.

## "Image Turn" Mode for Higher Resolution

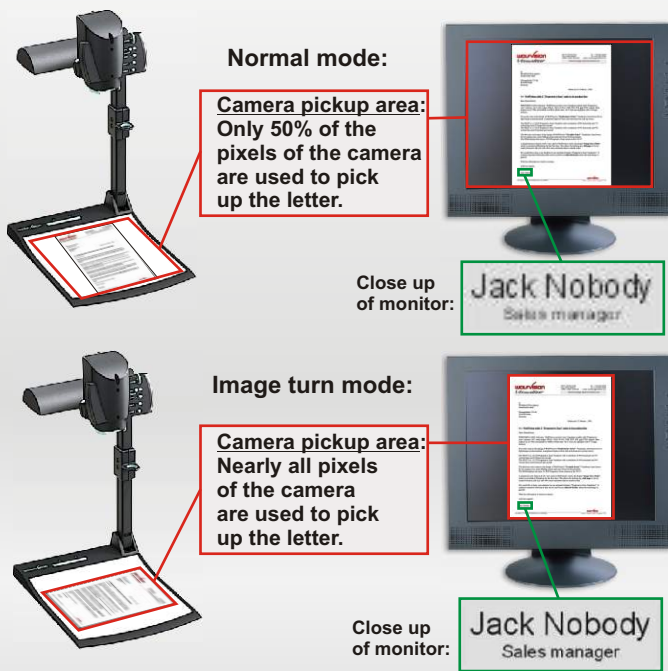

Picking up a complete vertical (portrait) letter or A4 sized page has always been a critical issue for a Visualizer because the image has always been picked up in a horizontal (landscape) format. As a result, only 50% of the camera pixels could be used to pick up the vertical (portrait) document.

WolfVision's unique "Image Turn" mode solves this problem. The user places the document on the working surface horizontally and zooms in on it completely. In doing so, approximately 90% of the camera's effective pixels are used to pick up the document. WolfVision's state-of-the-art electronics turn the image to a 90 degree angle and output it in a vertical format with 40% higher resolution. The margins left and right are blacked out.

In this mode, the resolution of a complete vertical (portrait) document is much better. Even 8-point characters are now readable.

Another advantage of the image turn mode is that very long vertical pages (like US legal format) can be picked up completely.

## Computer Input (Internal/External Switch)

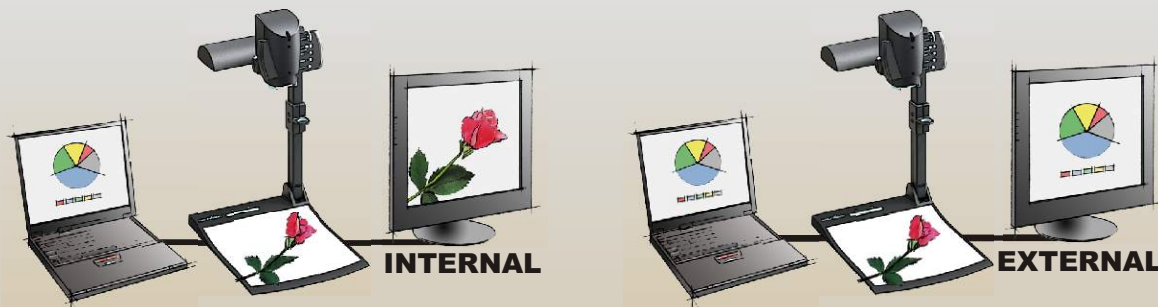

A computer can be connected to the RGB input (15-pin D-Sub-plug) of the Visualizer. With the Ext/Int switch, a user can switch between the Visualizer image and computer image to be output by the Visualizer's RGB output (15-pin D-Sub-plug).

Therefore, only one RGB cable is required to be attached to the display unit (projector, monitor, video conferencing system etc.) and no separate remote control has to be used for switching between the two image sources.

## USB 2.0 port / Twain / Video Capture / AVI

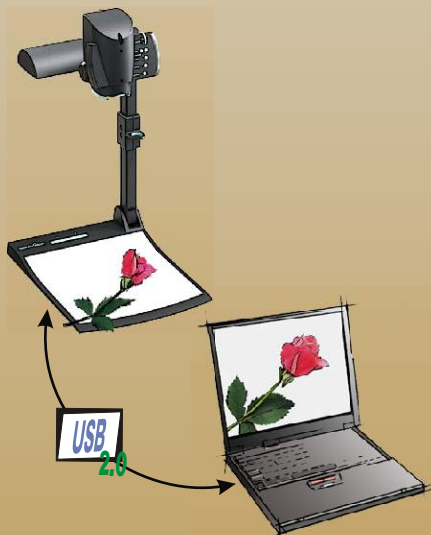

The USB output of the Visualizer can be used to transfer images from a Visualizer to a computer and save them in JPG, TIF or BMP format. This way, Visualizers can be used as **scanners for 3-dimensional objects**.

WolfVision Visualizers are equipped with a **fast USB 2.0 port**. This allows for uploading images onto a PC in a fraction of a second.

Connecting slower computers with the older USB 1.1 standard is also no problem. It still takes only a small fraction of the time a desktop scanner requires to scan an image.

WolfVision's USB software works under Windows 98, ME, 2000, XP and Apple Macintosh and is fully **Twain** compatible. This is important when using the Visualizer in connection with popular graphic programs such as Photoshop, or for connecting them to Interactive Whiteboards (Smart Boards).

The fast USB 2.0 port can also output **live motion**. The **WolfVision USB software can store AVI-files** and includes a **video capture** driver. You can view and save the live image from the Visualizer on your computer in almost every modern video editing software.

## Special Surface for Transparencies



All WolfVision Visualizers have a special **crystalline white working** surface for perfect reproduction of transparencies. The quality of a transparency on this surface is even better than with a bottom light, because there is more contrast and the colors are not "washed out".

The whole working surface has the same even color thus providing the perfect background for transparencies and other objects.

For x-rays or oversized slides, external lightboxes are available.

## High Speed Autofocus

The **continuously working** autofocus recognizes every object quickly and precisely. As a result, the presenter never needs to worry about focusing. The **high speed** of the autofocus is due to a special WolfVision software, which is analyzing 30 frames per second.

For special objects, a manual focus is also available.

## Optimized for Video Conferencing

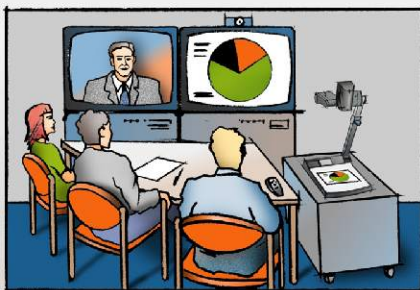

WolfVision's camera electronics produce a very strong and stable picture, which is very important when a Visualizer is used as a document camera for videoconferencing systems.

The even lighting, smooth auto iris and perfect focus are very important features, enabling video conferencing systems to digitize and transfer the picture from a WolfVision Visualizer much faster than pictures from other document cameras. Furthermore there is no blinding stray light from a WolfVision Visualizer, which could disturb the auto iris of the room camera.

Of course these features are equally important for live image presentations with a data projector and for other Visualizer applications.

Due to the "Image Flip" feature the Visualizers can also be used as an additional room camera of a videoconferencing system.

The VZ-8plus<sup>2</sup> has PAL/NTSC video outputs for video conferencing systems without data input. Plus it also supplies the proper signal for modern widescreen videoconferencing systems.

## 9 Picture Memory



The user has the opportunity to store 9 images and recall them by just pressing one of the numerical keys on the infrared remote control.

By pressing the "All" key, a split image with all 9 pictures of the memory can be displayed, enabling easy selection. The 9 pictures in the memory can also be downloaded to a PC via USB.

The Visualizer is equipped with a battery backup, so pictures remain in the memory for 1-4 weeks even when the power is disconnected.

The VZ-8light<sup>2</sup> offers a 1 image freeze function, instead of the 9 picture memory.

## Text Enhancer / Negative / Negative-Blue

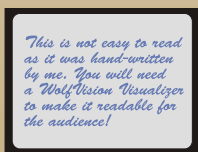

Original

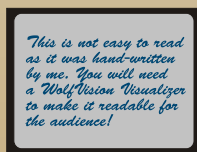

with Text Enhancer

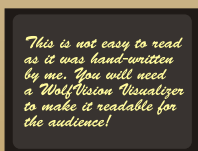

Negative

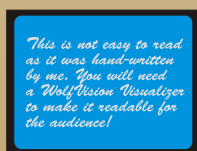

Negative/Blue

WolfVision Visualizers offer many possibilities to improve the readability of text.

With the "Text Enhancer" function, the outstanding contrast of the picture is improved even more with colors only slightly darker than before.

Dark text on a bright background can sometimes be easier to read if the Visualizer is switched to "Negative" or "Negative/Blue".

For special applications (like analyzing x-rays), the image can also be switched to **Black and White**.



# Firmware Updates via RS232 or USB



WolfVision's Visualizers are the only units on the market that offer upgradeable firmware. This allows **new features and technical improvements to be added at no cost!**

Downloading firmware updates from the internet and uploading them onto the Visualizer is very easy. The user can choose from 2 different connections between Visualizer and computer for updating the firmware: **Serial (RS232)** or **USB**.

WolfVision's engineers are constantly working on new improvements and features to **keep your units up to date with the technology of tomorrow!**



## Infrared Remote Control / Additional Features



The VZ-8plus<sup>2</sup> is supplied with a remote control. In addition to the features described above, the remote control also offers:

- Manual focus
- Auto focus on/off
- Manual iris
- 3 user programmable presets
- Laser pointer
- Easy navigation for on-screen menu and on-screen help

## External Controlling

There are 3 different possibilities to control the Visualizers from external devices, such as a room control system, a video conferencing system or a computer:

- Serial RS232
- USB
- Infrared (VZ-8plus<sup>2</sup>)



## Anti-theft devices

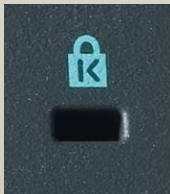

The Visualizer has two anti-theft devices.

On the bottom of the working plate is a thread for attaching the unit to a table with the supplied **table lock bolt**.

## Slide Drawer

Slides can be picked up in exceptional quality without an external bottom light by just putting them into the slide drawer on the camera head of the VZ-8plus<sup>2</sup>.

**T-Lock (Kensington® Lock)** devices can also be used. The connection can be found on the bottom of the arm.

## Easy to carry

The Visualizer alone weighs only 5 kg (11 lbs). Together with its carrying case and power pack, it still weights only 7.8 kg (17 lbs).

WolfVision's Portable Visualizers come in a high quality carrying case, with pockets for all needed accessories.

## Dimensions

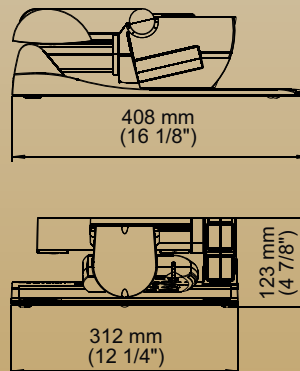
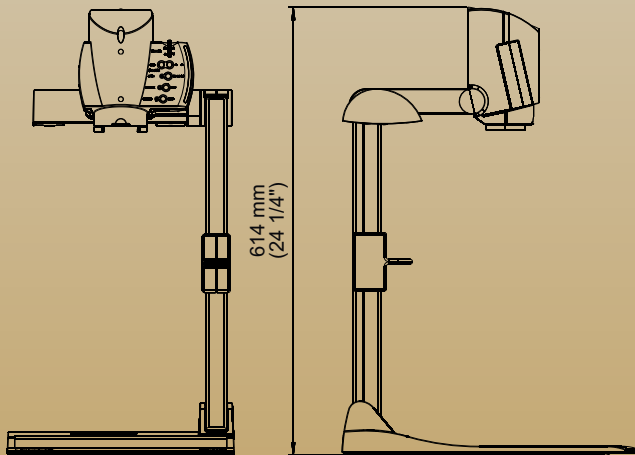

Detailed dimension drawings at: [www.wolfvision.com/support](http://www.wolfvision.com/support)

# Technical Data

	VZ-8light <sup>2</sup>	VZ-8plus <sup>2</sup>
Camera	1-CCD 1/3" Progressive Scan	1-CCD 1/3" Progressive Scan
Pictures per second (as picked up by the camera)	30 frames (=full pictures)	30 frames (=full pictures)
Effective Pixel (=pixels actually used for image information)	1024 x 768 (=786,462)	1024 x 768 (=786,462)
Total pixels of CCD(s)	850,000	850,000
Pixels processed per second (=pixels x frames per second)	23,600,000	23,600,000
Color reproduction / precision	very good colors	very good colors
Native signal output (4:3)	XGA (1024x768)	XGA (1024x768)
Converted output signals (4:3)	-	SXGA (1280x1024), SXGA- (1280x960), SXGA+ (1360x1024), SVGA (800x600), PAL and NTSC
Converted Widescreen output signals (16:9 and 16:10)	HD (High Definition) 720p at 50/60Hz, WXGA	HD (High Definition) 720p at 50/60Hz, WXGA
Resolution (measured)	640 lines	640 lines
Resolution in Image turn mode	-	820 lines
Image Turn mode (for increased resolution when picking up large portrait pages)	-	yes
Image Rotation	-	90, 180 and 270 degrees
Vertical image-frequency	Prog.Scan: 75 Hz or 60 Hz (switchable)	Prog.Scan: 85, 75 and 60 Hz (switchable), PAL: 50 Hz, NTSC: 60 Hz
Horizontal image-frequency	47,7 or 60.2 kHz	15.7 and 37.3 - 90 kHz
Signal format	non-interlaced	non-interlaced and interlaced
Iris	automatic (manual in on-screen menu)	automatic and manual
White balance adjustment	automatic and manual	automatic and manual
Autofocus / Speed	yes (continuously working, high speed)	yes (continuously working, high speed)
Manual focus	yes	yes
Text Enhancer	yes	yes
On screen menu and on screen help	yes	yes
Firmware Updates via	USB, RS232	USB, RS232
Lens / Zoom	24 x zoom (12x optical + 2x digital), with 2-speed zoom wheel	24 x zoom (12x optical + 2x digital), with 2-speed zoom wheel
Max object height on working surface	230mm (9.6") in tele position 370mm (15") in wide position	230mm (9.6") in tele position 370mm (15") in wide position
Max. pick-up area on working surface	Length: 276mm (10.9"), Width: 370mm (14.6")	Length: 276mm (10.9"), Width: 370mm (14.6")
Max. pick-up area on working surface in Image Turn mode	-	Length: 370mm (14.6"), Width: 276mm (10.9")
Min. pick-up area on working surface (with optical zoom)	33 x 25 mm (1.3" x 1")	33 x 25 mm (1.3" x 1")
Min. pick-up area on working surface (with digital zoom)	17 x 13 mm (0.7" x 0.5")	17 x 13 mm (0.7" x 0.5")
Max. pick-up area outside of working surface	unlimited	unlimited
Depth of focus on small object (42 x 33 mm)	10mm (0.4")	10mm (0.4")
Depth of focus on large object (360 x 270 mm)	260mm (10.2")	260mm (10.2")
Blinding of audience or speaker	none	none
Light source	long life high frequency fluorescent lamp	long life high frequency fluorescent lamp
USB software for image capturing and controlling	included (for Windows and Macintosh, Twain compatible, with video capture driver)	included (for Windows and Macintosh, Twain compatible, with video capture driver)
Time for still image capture through USB software	approx. 1/2 sec. (with fast PC and USB 2.0)	approx. 1/2 sec. (with fast PC and USB 2.0)
Reflection free area on working surface	whole working surface	whole working surface
Recordings outside of the working surface	yes (to the back and to the front of the unit)	yes (to the back and to the front of the unit)
Automatic image flip	yes (for recordings to the front of the unit)	yes (for recordings to the front of the unit)
Intelligent folding system	pneumatic arm, 2-step set up	pneumatic arm, 2-step set up
User programmable presets	1 (plus 2 programmable and 8 fixed through RS232)	3 (plus 8 fixed presets through RS232)
Special working surface for transparencies	yes	yes
Slide pick-up	with optional lightbox	through slide drawer on camera head
External computer input / Input switch	yes (15-pin D-Sub/VGA plug)	yes (15-pin D-Sub/VGA plug)
Image memory	1 image freeze	9 pictures
"Show all" function (9 picture split-screen)	-	yes
Alternative Image display	negative image / negative-blue image / black and white image	negative image / negative-blue image / black and white image
Y/C (=S-video) output	-	one (converted Prog.Scan), 4-pin
Composite outputs	-	one (converted Prog.Scan) RCA
RGB output	one (15-pin D-Sub/VGA-plug)	one (15-pin D-Sub/VGA-plug)
DVI output	-	DVI-D (digital)
HDMI output	-	when using a DVI-HDMI cable
USB port / standard	USB 2.0	USB 2.0
RS232 port, protocol with position setting and status report	9-pin D-Sub	9-pin D-Sub
Weight	5 kg (11 lbs)	5 kg (11 lbs)
Infrared remote control	-	yes (with laserpointer)
Antitheft device	T-Lock (Kensington® Lock) and table lock bolt	T-Lock (Kensington® Lock) and table lock bolt
Power (external power pack on portable units)	multi range 100-240 V, 20W weight: 0.3kg (0.6lbs)	multi range 100-240 V, 20W weight: 0.3kg (0.6lbs)
Carrying case	included (soft case)	included (soft case)
Warranty	3 years	3 years

Printed in Austria, January 2008

Your WolfVision dealer:

Specifications and availability subject to change !

More information on our Internet Homepage:  
[www.wolfvision.com](http://www.wolfvision.com)

**WOLFVISION**  
*Visualizer*

WolfVision GmbH - Vlb. Wirtschaftspark, A-6840 Götzis / AUSTRIA, Tel. ++43/(0)5523/52250, Fax ++43/(0)5523/52249, E-mail: [wolfvision@wolfvision.com](mailto:wolfvision@wolfvision.com)

USA distribution: WolfVision Inc, Duluth (Atlanta), GA 30096 / USA, Tel.(770)931-6802, Tollfree 1-877-873WOLF, Fax:(770)931-6906, [usa.east@wolfvision.net](mailto:usa.east@wolfvision.net)  
 WolfVision Inc, Burlingame (San Francisco), CA 94010 / USA, Tel.(650)648-0002, Tollfree (800)356-WOLF, Fax:(650)648-0009, [usa.west@wolfvision.net](mailto:usa.west@wolfvision.net)  
 Asia distribution: WolfVision Asia, Singapore 757718, Tel.++65-6366 9288, Fax: ++65-6366 9280, [info@wolfvisionasia.com](mailto:info@wolfvisionasia.com)  
 Canada distribution: WolfVision Canada Inc, Ottawa, ON K1J 1H7, Tel. 613-741-9898, Fax 613-741-3747, [wolfvision.canada@wolfvision.com](mailto:wolfvision.canada@wolfvision.com)  
 Japan / Australia distribution: WolfVision Co Ltd, Tokio, Zip 160-0023, Tel.(++81)3-33603231, Fax:(++81)3-33603236, [wolfvision.japan@wolfvision.com](mailto:wolfvision.japan@wolfvision.com)  
 United Kingdom distribution: WolfVision UK Ltd, Manchester, M22 5XB, Tel. 0161 435 6081, Fax: 0161 435 6100, [wolfvision.uk@wolfvision.com](mailto:wolfvision.uk@wolfvision.com)